

Surf. au sol / Superf. interna netta/ Internal surface : 2,53 m²

Surf. hors tout / Superficie totale/ Total surface : 2,80 m²

Pente de toit/ Pendenza tetto/ Roof slope : 13 °

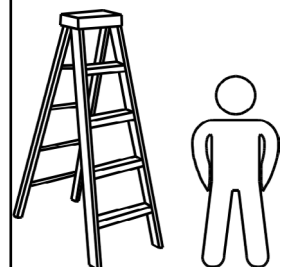

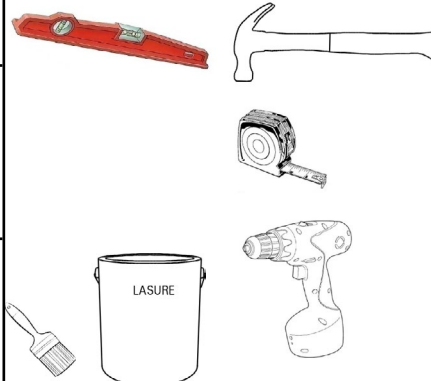
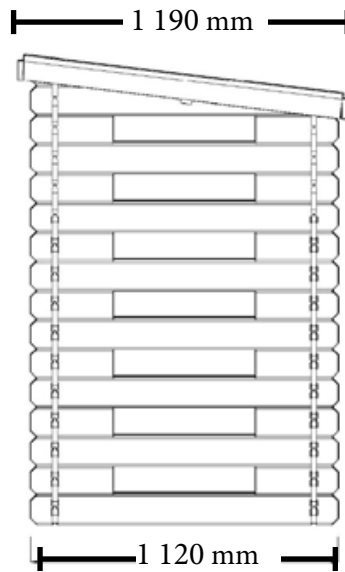
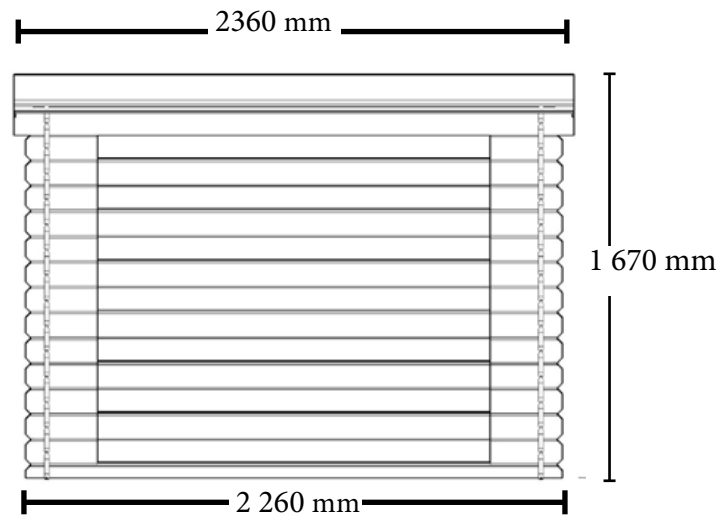

Plan de soubassement RB 2311

Piano di basamento RB 2311

Basement plan RB 2311

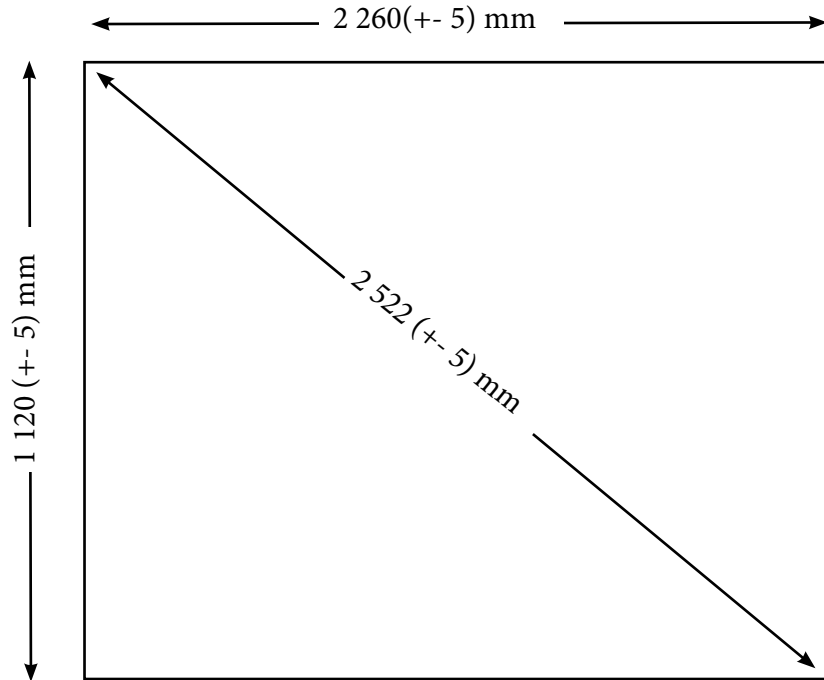





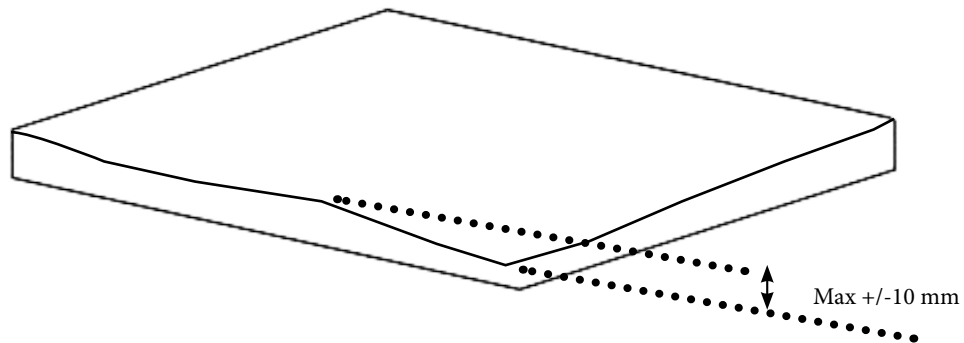

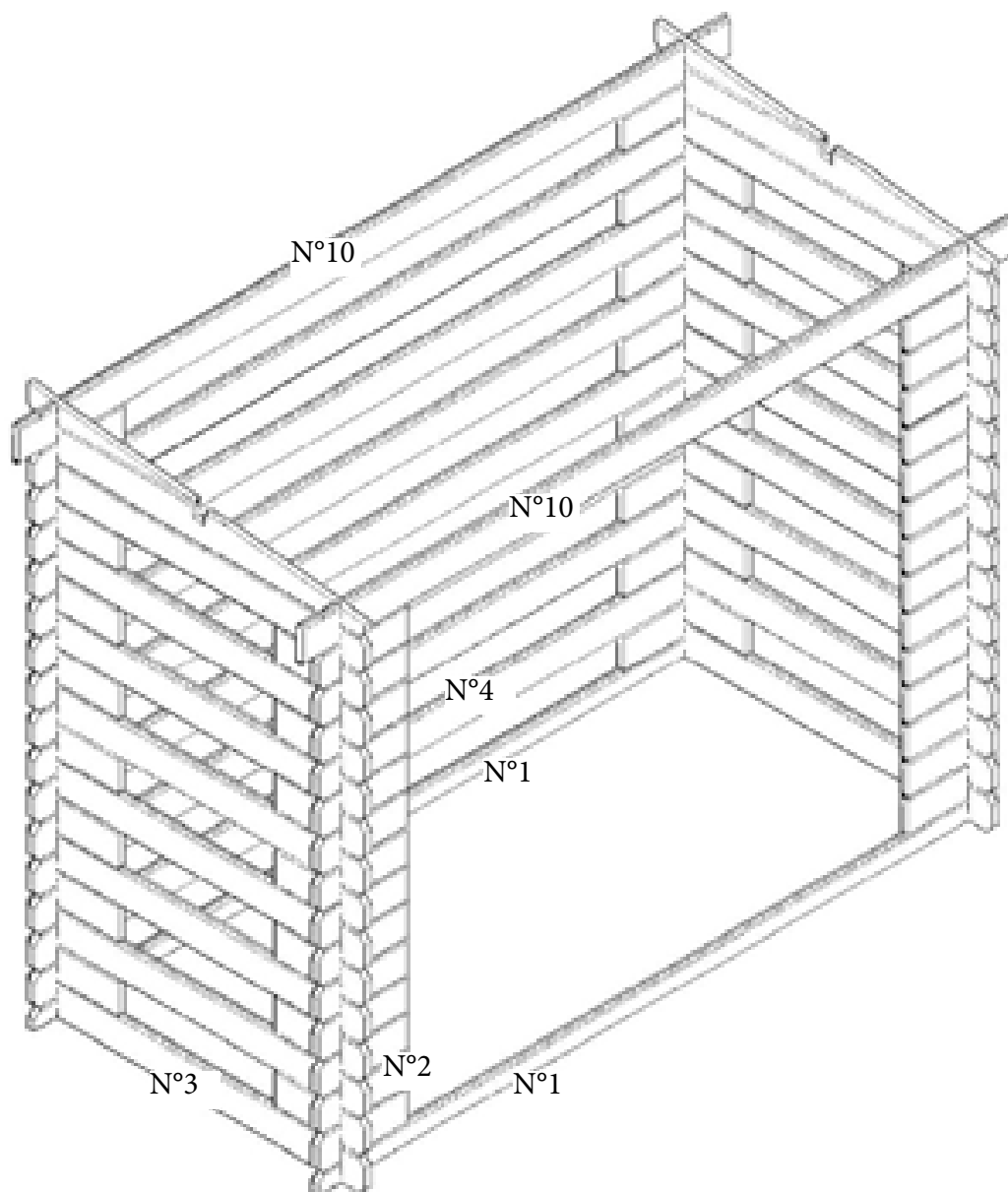



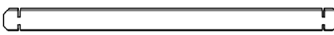
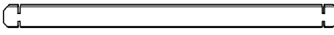



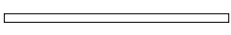

Les dimensions données sur le plan de soubassement sont les dimensions de la dalle béton à réaliser sur un sol parfaitement plat sans aucun autre objet extérieur type mur, clôture ou arbre dans l'entourage de la dalle. Si le produit est implanté près d'un mur, d'une haie ou d'un arbre il est nécessaire de l'éloigner des éléments extérieurs afin de pouvoir facilement le monter et l'entretenir. Nous nous dégageons de toute responsabilité en cas de mauvaise interprétation des dimensions de la dalle.

Le dimensioni del piano di base sono le dimensioni della soletta di cemento da realizzare su un terreno perfettamente piatto, senza alcun altro oggetto esterno, come un muro, una recinzione o un albero in prossimità della soletta. Se il prodotto è installato vicino ad una parete, un recinto o un albero, è necessario distanziarlo adeguatamente, in modo da poterlo facilmente montare e farne la manutenzione. Non ci assumiamo alcuna responsabilità per l'errata interpretazione delle dimensioni della lastra.





| | | | | | | Demande sav | | |
|---|--------------|---|------------------|-----|--|-------------|-----|--|
| N° | REF | DES. | DIM (mm) | QTE | | OBS | QTE | |
| 1. | I20.2.2260 |  | 2260 x 55 x 20 | 2 | | | | |
| 2. | L20.1.300 |  | 300 x 108 x 20 | 72 | | | | |
| 3. | L20.2.1120 |  | 1120 x 108 x 20 | 16 | | | | |
| 4. | L20.2.2260 |  | 2260 x 108 x 20 | 7 | | | | |
| 5. | F20.1120.172 | | 1120 x 160 x 20 | 2 | | | | |
| | | | 1120 x 108 x 20 | 2 | | | | |
| | | | 570 x 108 x 20 | 2 | | | | |
| 6. | GL2360.70 |  | 2360 x 70 x 40 | 2 | | | | |
| 7. | DSF2400.90 |  | 2400 x 70 x 20 | 2 | | | | |
| 8. | DSF1170.70 |  | 1170 x 70 x 20 | 2 | | | | |
| 9. | DSF1170.70 |  | 1170 x 40 x 20 | 2 | | | | |
| 10. | LSS20.2.2360 |  | 2360 x 108 x 40 | 1 | | | | |
| | LSD20.2.2360 |  | 2360 x 108 x 40 | 1 | | | | |
| 11. | OND664.1000 |  | 2360 x 1170 x 12 | 1 | | | | |
| 12. | |  | 2400 x 1000 x 3 | 1 | | | | |
| | |  | 2400 x 500 x 3 | 1 | | | | |
| Détail sachet de visserie/Bustina de fermento/Iron bag | | | | | | | | |
| 24 | Clous L80 |  | 70 | 9 | | | | |
| 25 | Vis 3,0 x 30 |  | 3,0 x 30 | 100 | | | | |
| 26 | Clous L40 |  | 1,8 x 40 | 30 | | | | |
| 27 | Clous L16 |  | 16 | 160 | | | | |

A compléter impérativement pour toute demande SAV et à envoyer par mail à sav@foresta.fr + photo des pièces abîmées (To be completed imperatively + Photo of damaged parts)

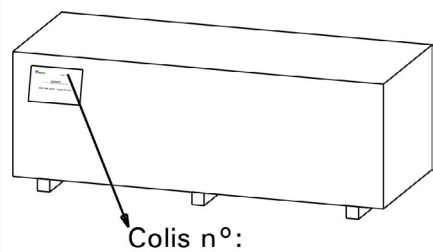

RB 2311

Colis(package) n° :

MAGASIN (STORE)

NOM (NAME) CLIENT

**PRENOM(PRE.)
CLIENT**

TEL.



