

DOMUS

ISTRUZIONI DI MONTAGGIO CASETTA IN RESINA LEONOR 4X3 COLORE GRIGIO E NERO - 440507



Alcune parti dei pannelli possono risultare taglienti, pertanto si raccomanda la massima cautela nel movimentare le componenti. Si rende obbligatorio l'utilizzo di guanti antitaglio per evitare gravi lesioni. Eventuali incidenti avvenuti per il mancato rispetto di tale prescrizione non sono coperti da garanzia.



INDICE

PRIMA DI INIZIARE	3
LISTA DEI COMPONENTI	4
VISIONE D'INSIEME	5
PREASSEMBLAGGIO DELLA BASE	6
PREASSEMBLAGGIO PARETE POSTERIORE	6
PREASSEMBLAGGIO PARETI LATERALI	7
PREASSEMBLAGGIO PARETE FRONTALE	7
PREASSEMBLAGGIO PORTA	8
PREASSEMBLAGGIO TRIANGOLO SUPERIORE	9
PREASSEMBLAGGIO TETTO	9
AVVERTENZE	18

PRIMA DI INIZIARE

Prima dell'installazione, è importante verificare con il proprio comune eventuali autorizzazioni necessarie per il posizionamento della casetta.

Le istruzioni fornite in questo manuale contengono tutte le informazioni necessarie per il corretto assemblaggio della casetta. Leggere attentamente tutte le istruzioni prima di iniziare.







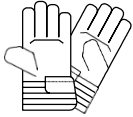

Durante il montaggio, seguire attentamente la sequenza dei passaggi per ottenere risultati corretti.

Attenzione: questo prodotto richiede due persone e circa un giorno intero per il montaggio.

Posizionamento della casetta:

- Evitare la presenza di alberi con rami sporgenti sopra la struttura: le foglie possono richiedere pulizie frequenti e i rami rotti possono rappresentare un pericolo.
- La presenza di piccoli arbusti o recinzioni nelle vicinanze può essere utile, poiché funge da frangivento.
- Il terreno deve essere livellato in tutta la sua superficie. Verificare la planarità utilizzando una livella a bolla.
- La superficie su cui posizionare la casetta può essere realizzata in legno trattato o in cemento, per impedire all'umidità di penetrare all'interno.
- Non montare direttamente la casetta sul prato: in caso di pioggia, il terreno potrebbe diventare fangoso.
- Se si posiziona su una superficie in cemento, assicurarsi che abbia una leggera pendenza verso i bordi per evitare ristagni d'acqua.
- In alternativa, la superficie di base può essere costruita con mattoni o blocchi posati su fondazioni in cemento solide e perfettamente livellate. Il telaio dovrà essere forato e fissato alla base con viti.

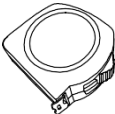
Attrezzatura necessaria NON inclusa:

				
Guanti antitaglio	Occhiali di sicurezza	Scarpe	Trapano elettrico	Punte da trapano
				
Cacciavite	Metro a nastro	Chiave inglese	Scala	

Consigli e avvertenze:

- Liberare l'area di lavoro per consentire l'accesso su 4 lati. Una superficie di lavoro rialzata faciliterà il montaggio.
- Le parti sono tutte identificate, seguendo le istruzioni pagina per pagina, potrete vedere nei diagrammi dove è posizionata la singola parte.
- **È obbligatorio l'utilizzo di guanti antitaglio, occhiali e scarpe protettive per evitare lesioni accidentali. Alcune parti possono risultare taglienti e pericolose, pertanto si raccomanda la massima cautela nel movimentare i componenti.**
- Tenere i bambini lontani dall'area di lavoro.
- **Non montare la casetta in caso di vento per evitare danni alle parti o lesioni personali. Prestare attenzione in caso di terreno bagnato o fangoso.**
- Disimballare tutti i pezzi e posizzarli all'esterno dell'area di lavoro, verificare la presenza di tutte le parti confrontandole con l'elenco dei componenti che trovate nella pagina successiva.
- Pulire tutti i pezzi di metallo, rivetti e viti.

Eurobrico Spa declina ogni responsabilità nel caso in cui l'acquirente non segua pedissequamente le istruzioni di montaggio ed i consigli e avvertenze previsti, munendosi dell'adeguata attrezzatura necessaria; il tutto come indicato nel presente manuale Domus "Istruzioni di Montaggio" che si suggerisce di leggere con attenzione e in maniera completa.

LISTA DEI COMPONENTI











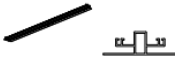

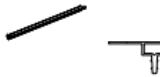



























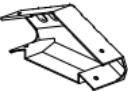





FOTO	CODICE	PEZZI	VERIFICA	FOTO	CODICE	PEZZI	VERIFICA
	A34-A01	2			A34-C15	2	
	A34-A02	1			A34-C16	4	
	A34-C01	1			A34-C17	2	
	A34-C02	1			A34-C18	2	
	A34-C03	1			A34-C19	2	
	A34-C04	1			A34-C20	1	
	A34-C05	2			A34-C21	2	
	A34-C06	6			A64-A02	1	
	A34-C07	2			A64-A05	1	
	A34-C08	6			A64-A06	2	
	A34-C09	1			A64-A15	2	
	A34-C10	3			A64-V4-A01	1	
	A34-C11	2			A64-V4-A02	1	
	A34-C12	1			A64-V4-A07	1	
	A34-C13	4			A64-C04	3	
	A34-C14	4			A64-C19	4	

FOTO	CODICE	PEZZI	VERIFICA	FOTO	CODICE	PEZZI	VERIFICA
	A64-C29	2			F35-C33	1	
	A64-C32	2			F35-C34	1	
	A64-C33	2			E01 (ST4.2*13)	20	
	A86-V4-A01	1			E02 (ST4.2*12)	242	
	F35-C27	4			E03 (ST4.8*19)	24	
	F35-C29	4			E04 (ST5.5*50)	4	
	F35-C30	4			E12	12	
	F35-C31	1			D02	1	
	F35-C32	1			D03	1	

VISIONE D'INSIEME



PREASSEMBLAGGIO DELLA BASE

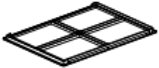
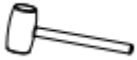
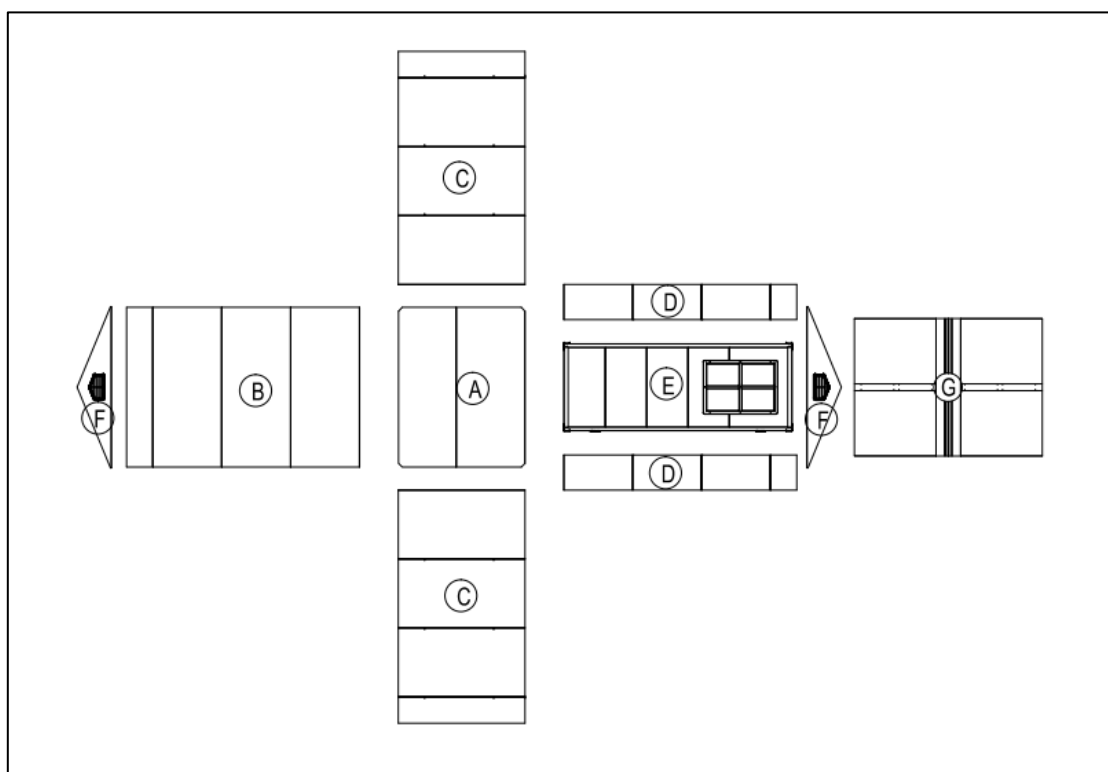

A34-C01



A34-C02



E02 x2



I

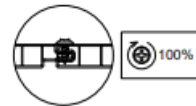
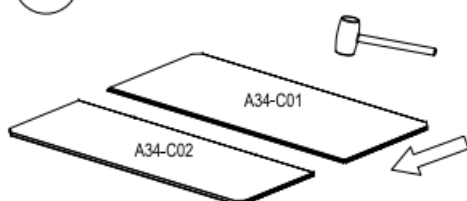

II

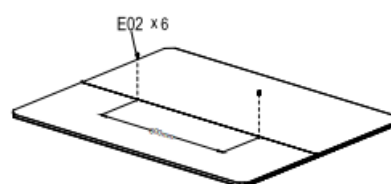

PREASSEMBLAGGIO PARETE POSTERIORE



A34-C09



A34-C10 x3



E02 x6



I

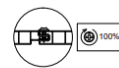
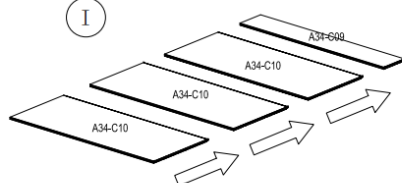

II

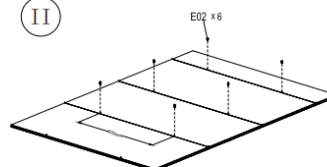

PREASSEMBLAGGIO PARETI LATERALI

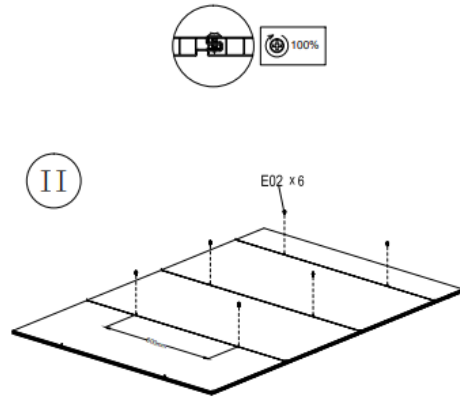
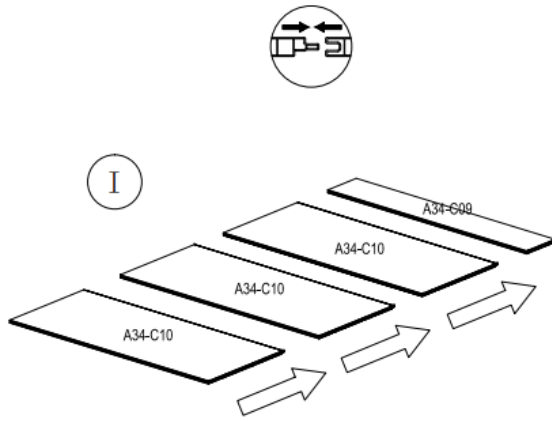

X2

PREASSEMBLAGGIO PARETE FRONTALE

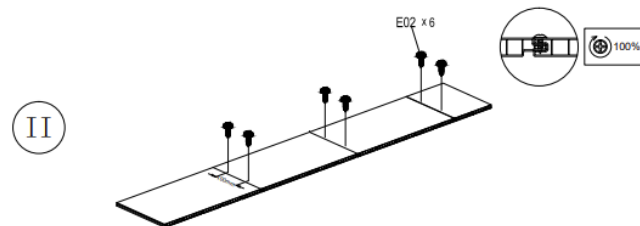
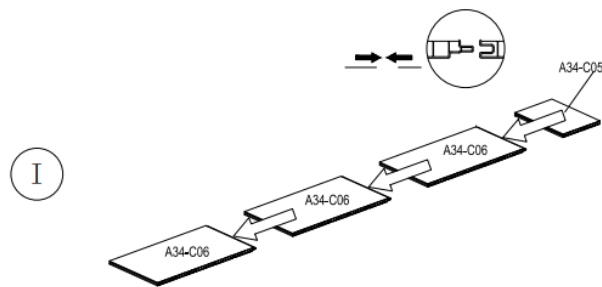
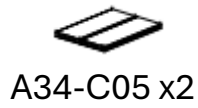

X2

PREASSEMBLAGGIO PORTA

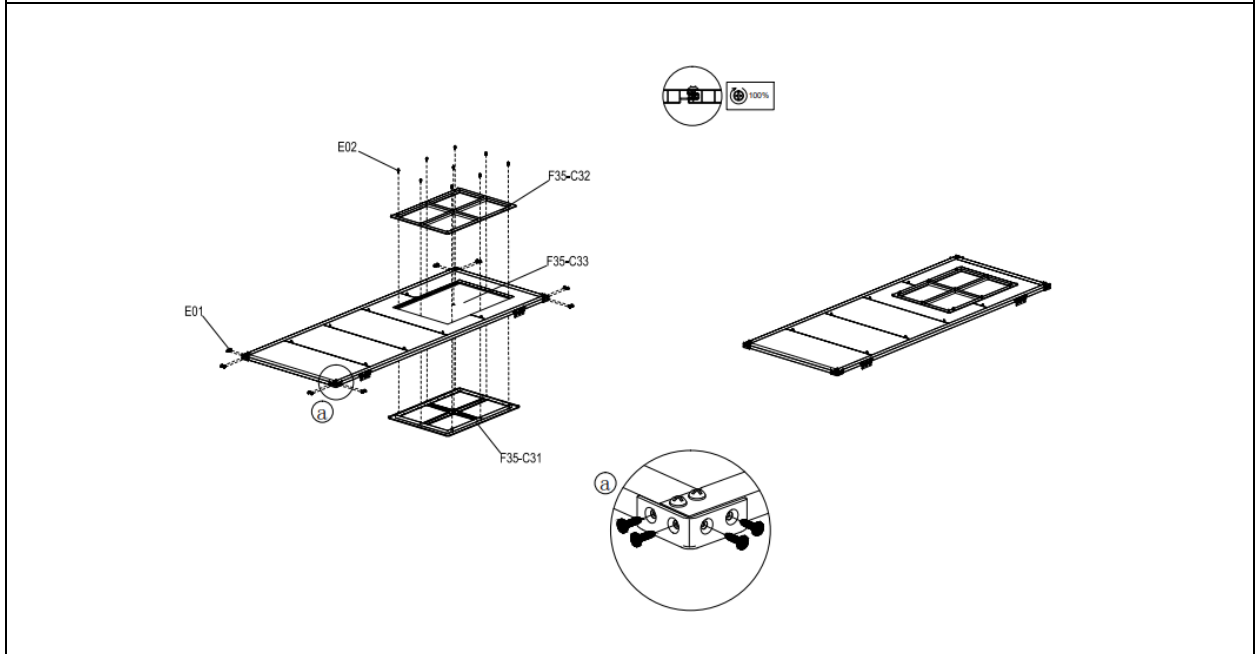
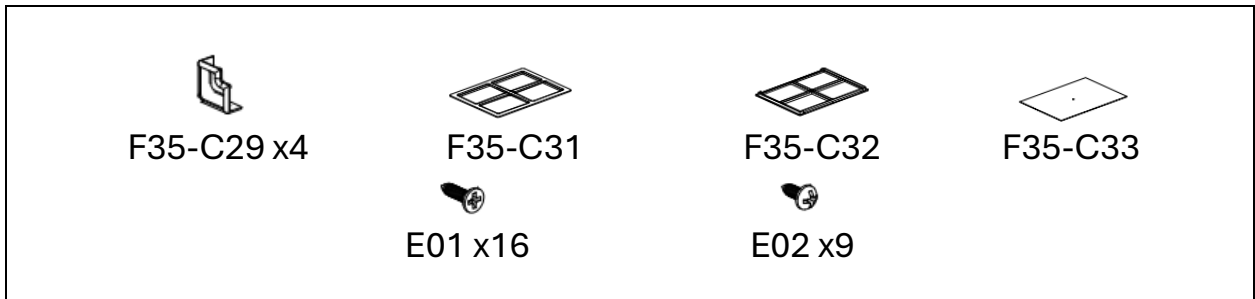
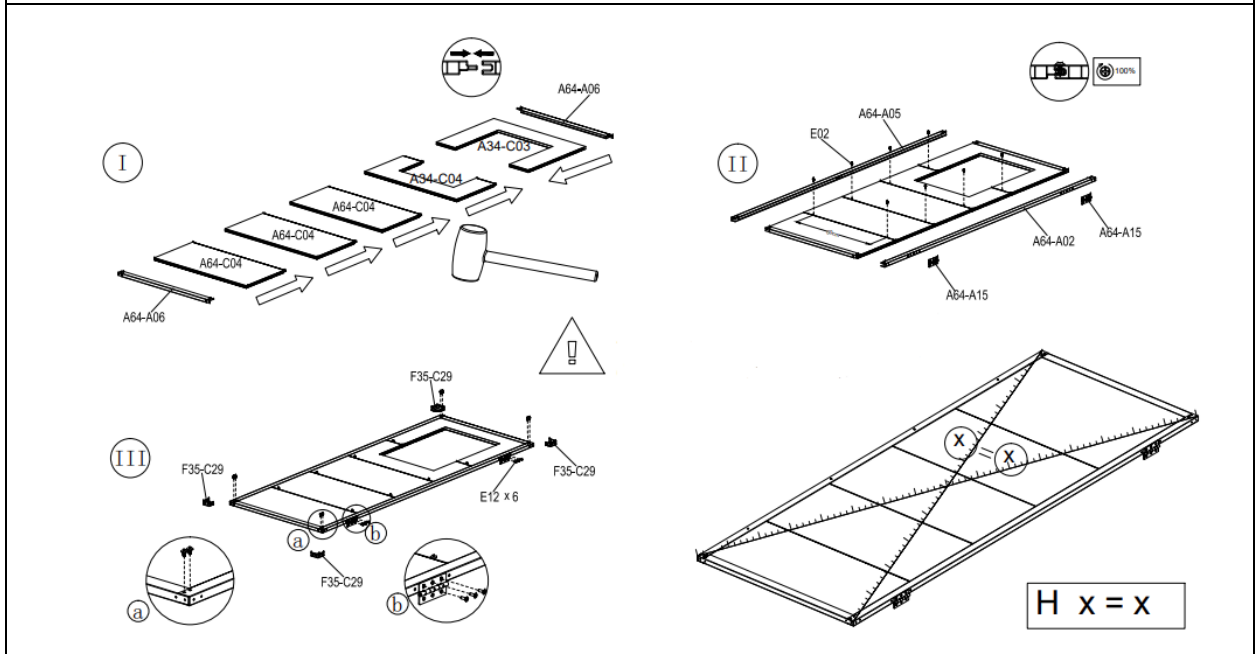
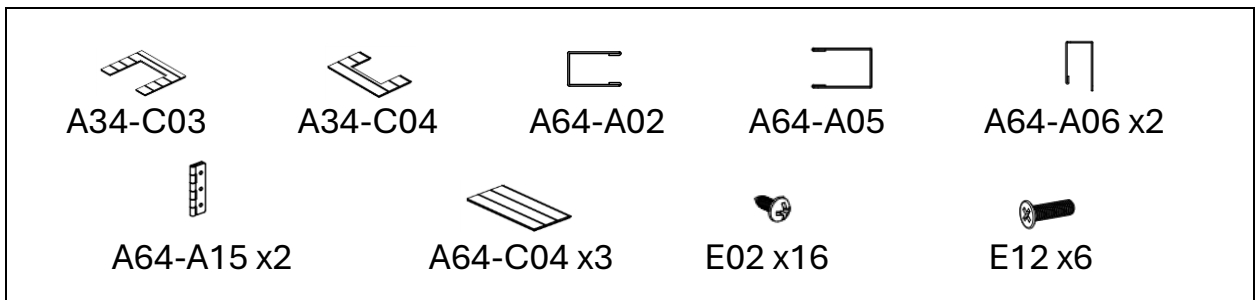

PREASSEMBLAGGIO TRIANGOLO SUPERIORE



A34-C11 x2



A64-C32 x2



A64-C33 x2



E02 x8

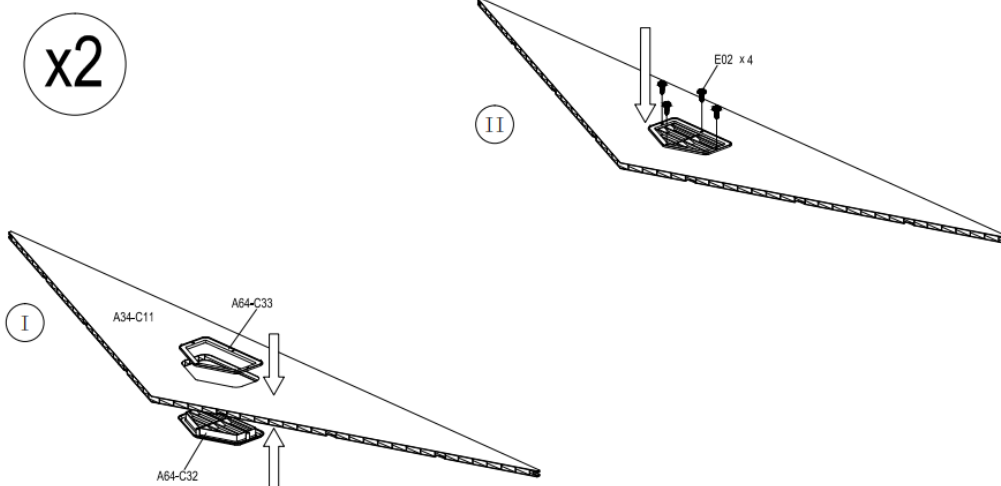

PREASSEMBLAGGIO TETTO



A34-A01 x2



A34-C12



A34-C13 x4



E02 x16

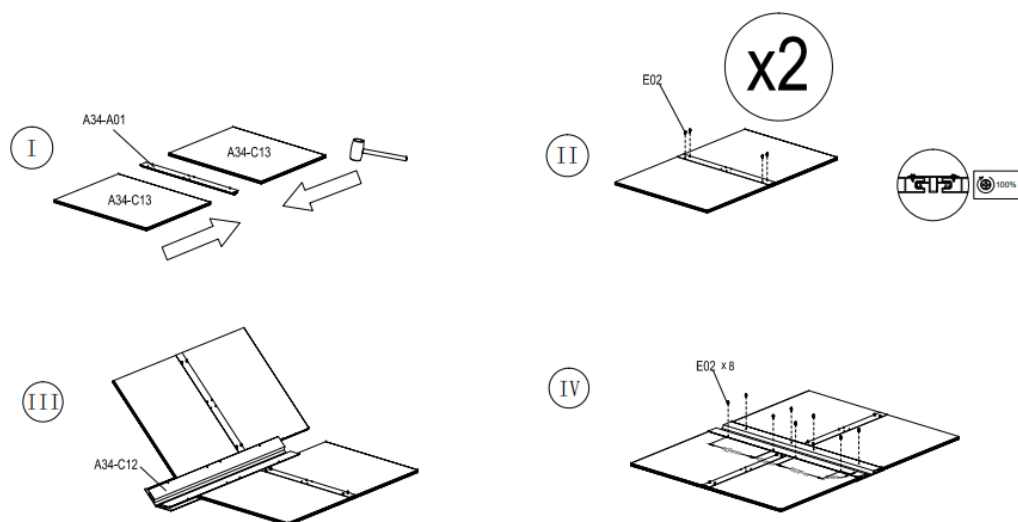



A34-A02



E02 x8

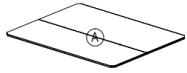
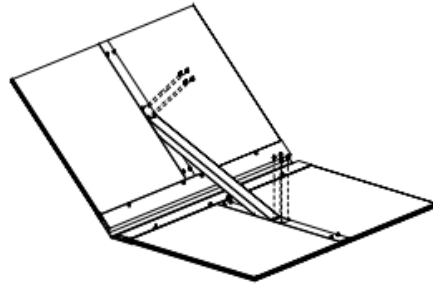
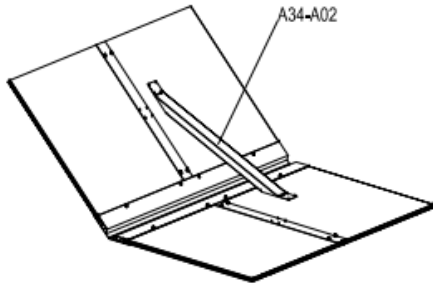

A34-C18 x2



A34-C19 x2



F35-C27 x4



E02 x16

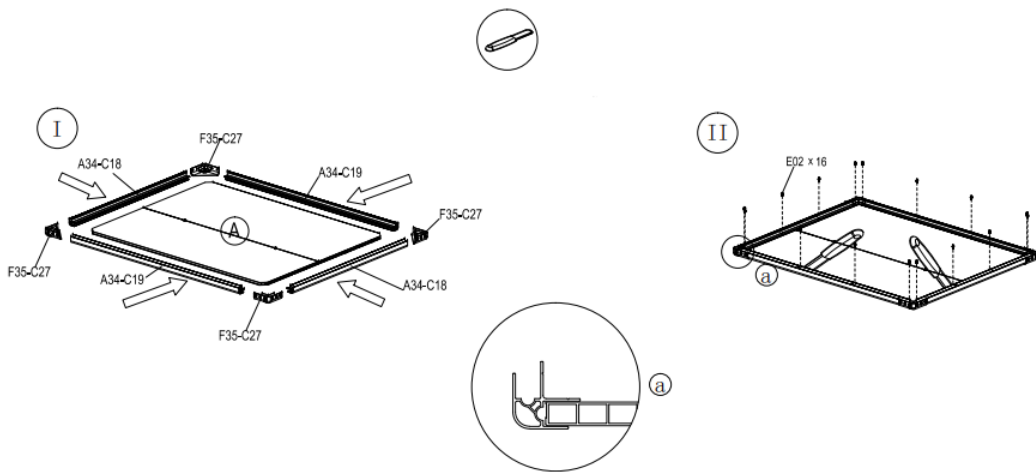

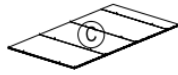
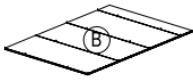

A64-C19 x1

E02 x12

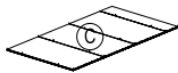
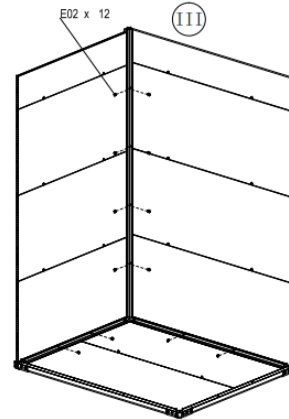
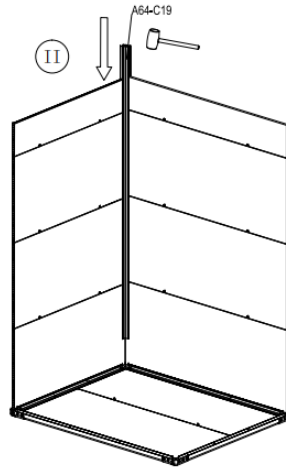
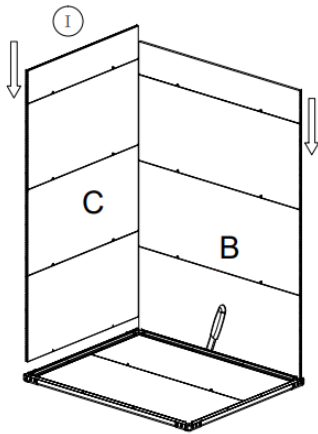

A64-C19 x1

E02 x10

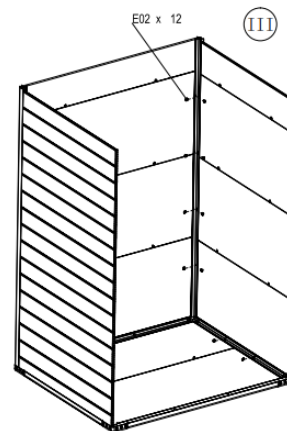
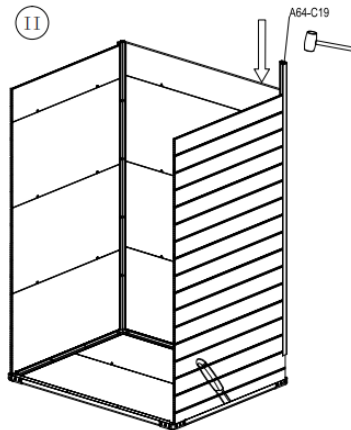
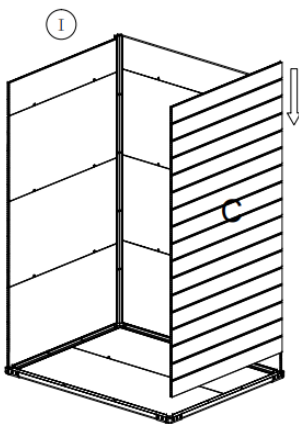



A64-C19 x1



E02 x 10

I

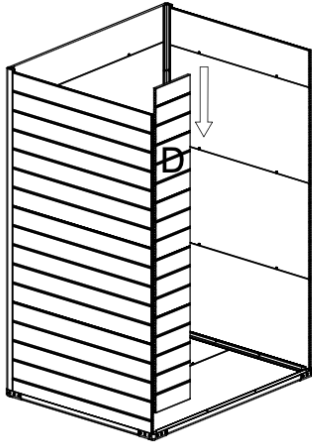

II

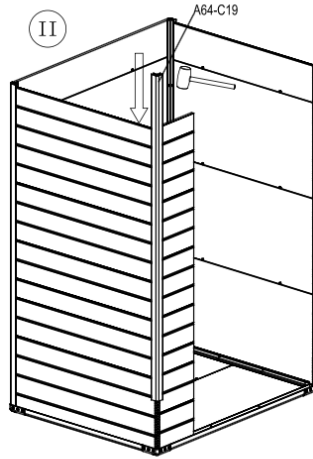

III

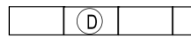
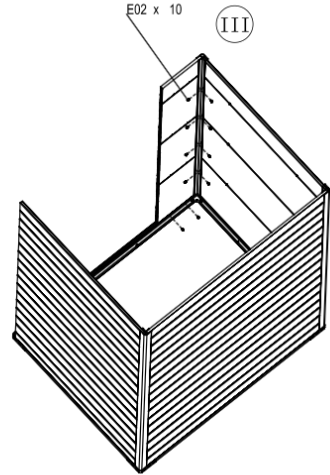

A64-C19 x1



E02 x 10

I

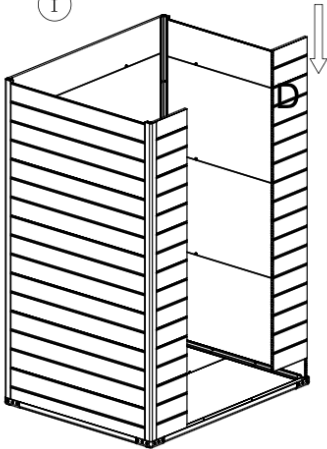

II

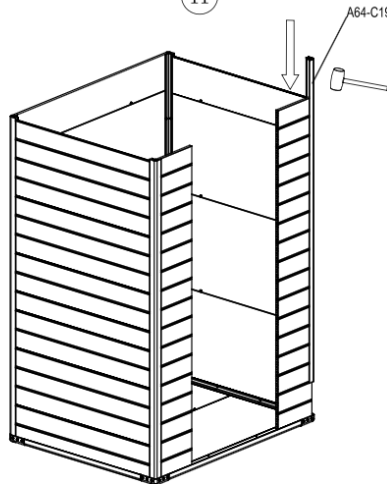

III

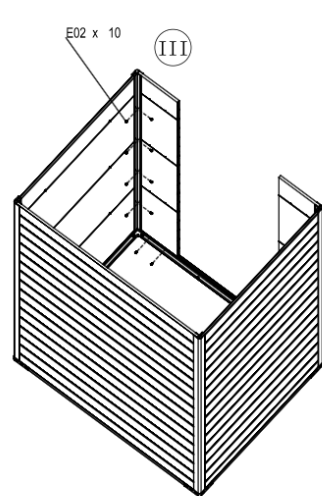



A64-V4-A01



A64-V4-A00



A64-V4-A07



A86-V4-A01

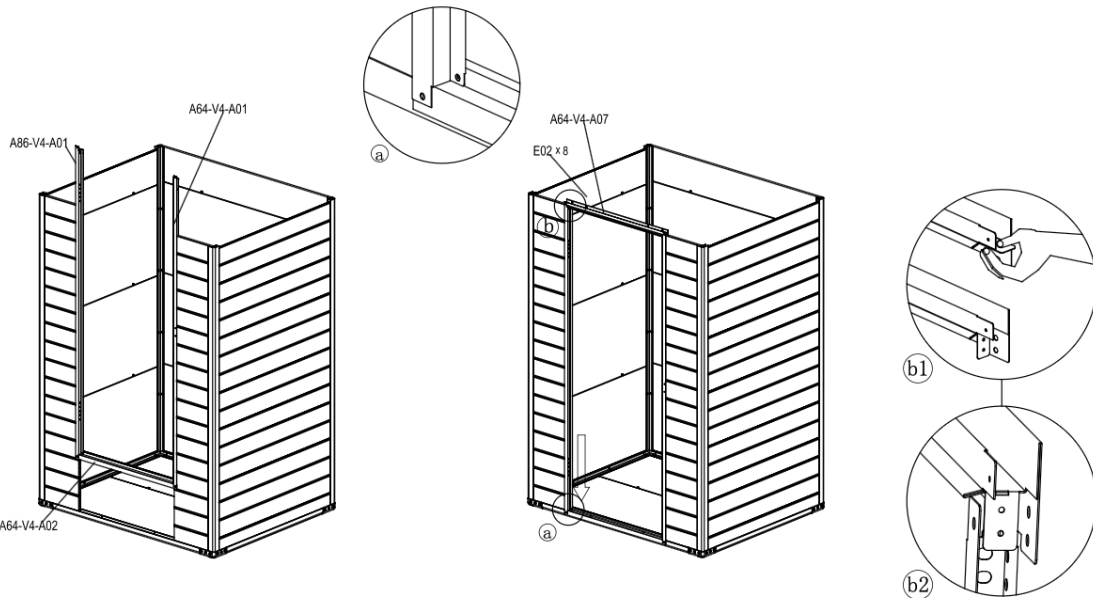

E02 x 23

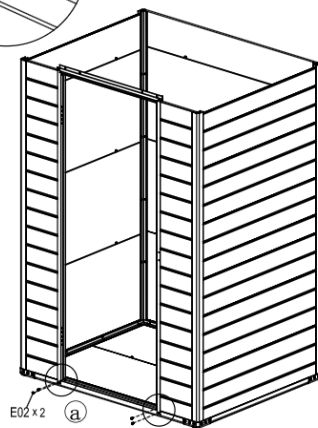
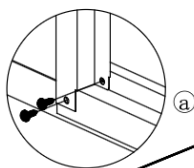

E02 x 2

(a)

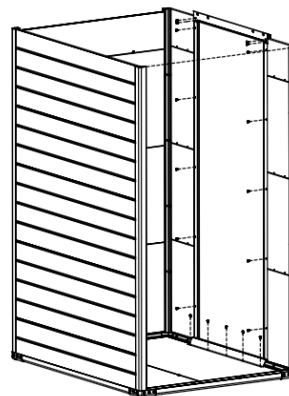



A34-C21 x2

E02 x14

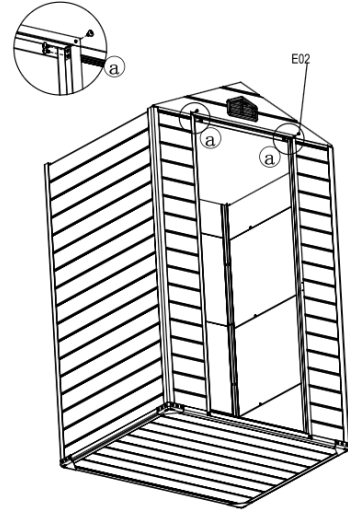
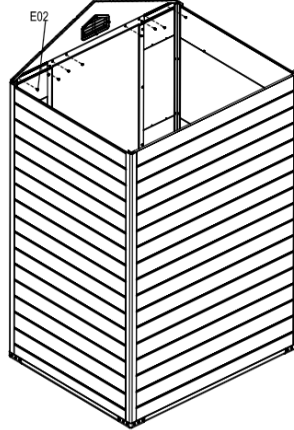
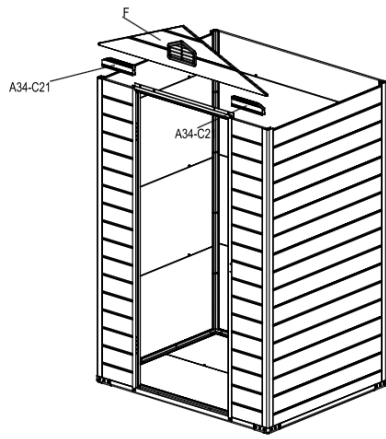

A34-C20

E02 x10

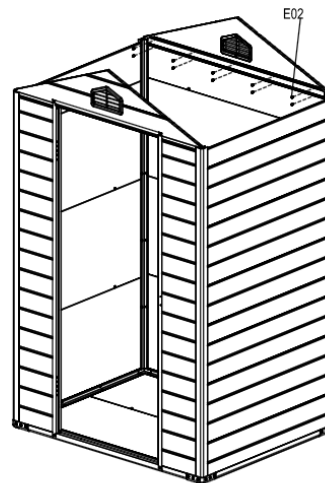
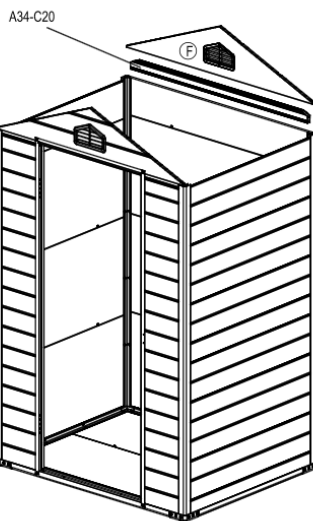

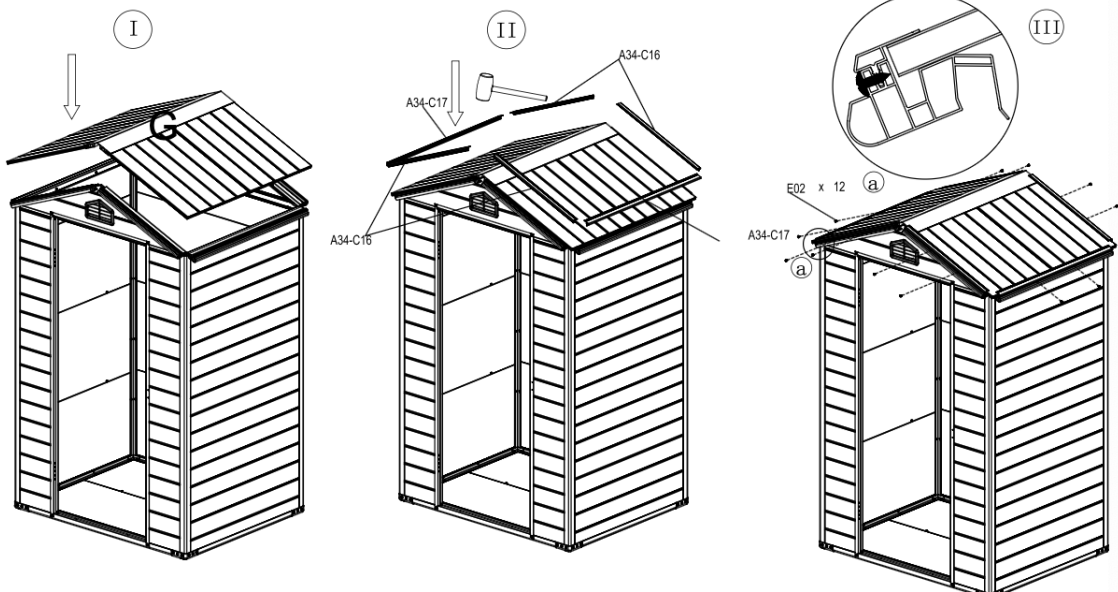
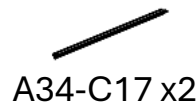
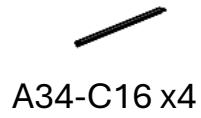
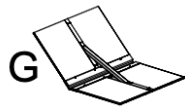
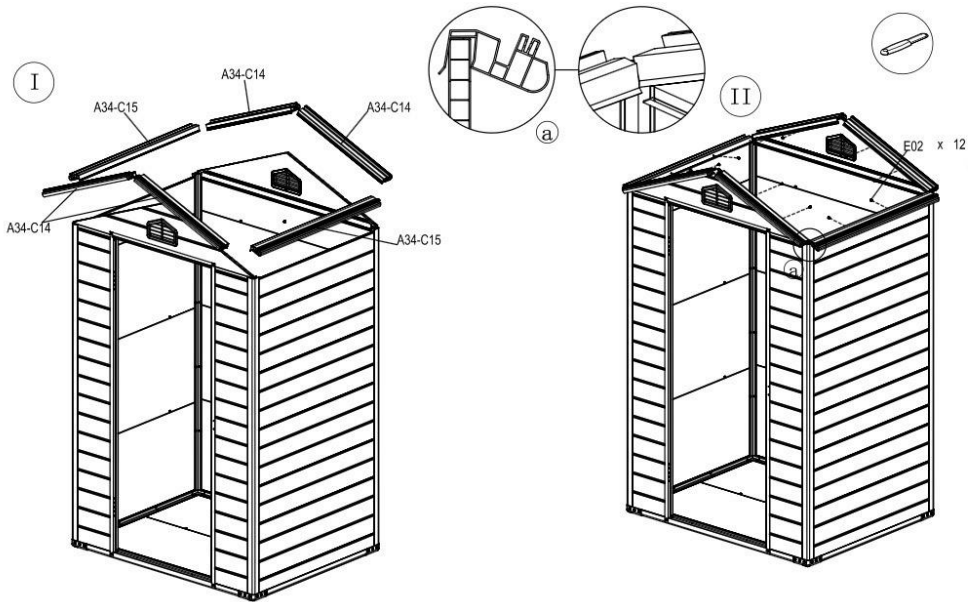
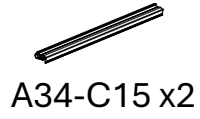
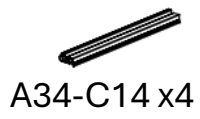

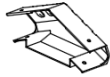

A64-C29 x2



F35-C30 x4



E02 x24

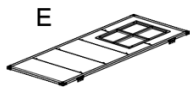
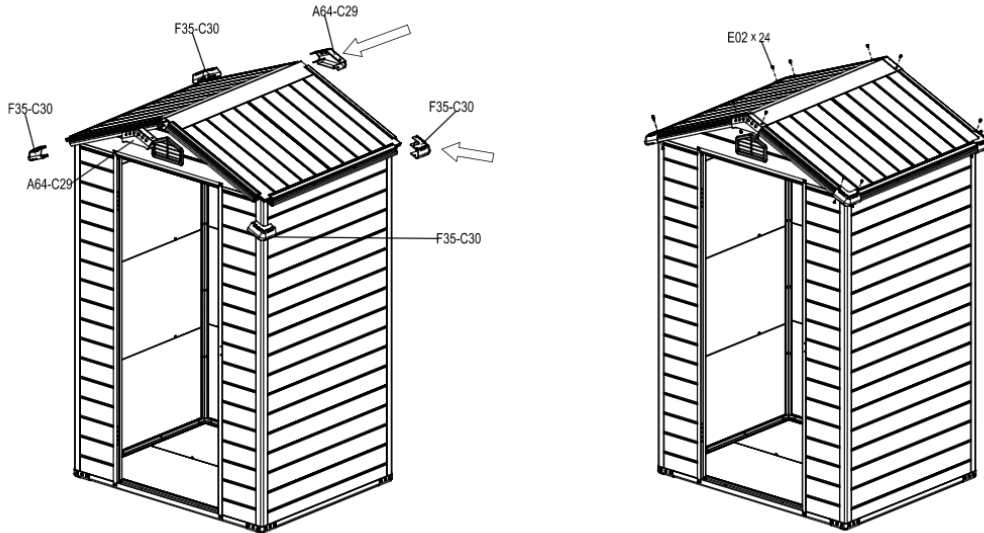

E



D02



E01 x4



E12 x6

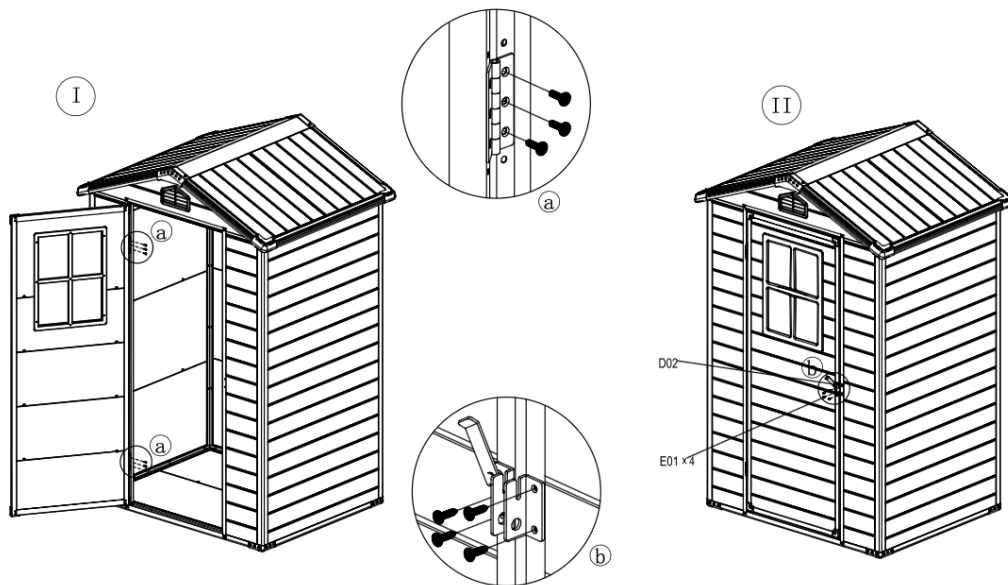

E03 x24

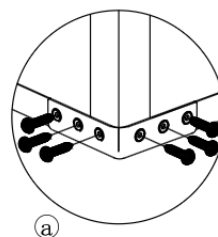
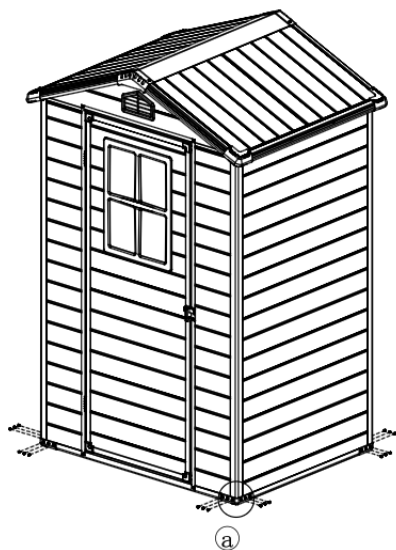

E04 x4

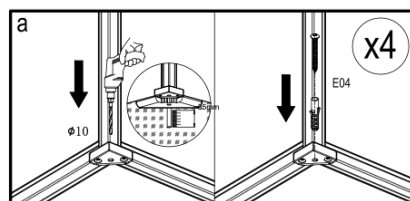
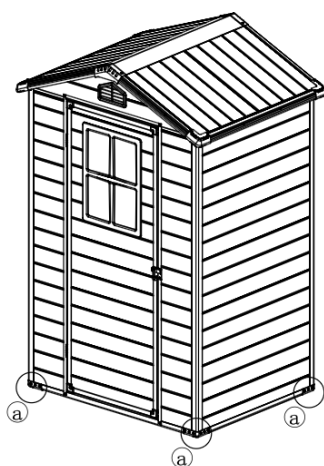

AVVERTENZE

Gentile Cliente,

grazie per aver scelto questa casetta DOMUS. Al fine di garantire la massima sicurezza, la preghiamo di attenersi alle istruzioni di montaggio indicate in questo manuale.



Conservare il presente manuale per eventuali consultazioni future

- Il presente manuale di installazione, d'uso e manutenzione è parte integrante del prodotto. Una copia del manuale è reperibile sul sito internet www.eurobrico.com.
- L'installazione deve avvenire nel rispetto del presente manuale; in caso di necessità, per chiarimenti o assistenza, contattare il servizio clienti su <https://www.eurobrico.com/it/contattaci-parla-con-noi/>

NOTA: Si informa che ci potrebbero essere delle piccole discrepanze fra il manuale ed il prodotto reale, ci scusiamo per eventuali differenze che non costituiscono comunque modifiche essenziali al prodotto, ma che sono dovute a continue migliorie e implementazioni del prodotto stesso.

La garanzia è da ritenersi valida solo se si rispettano le presenti istruzioni di montaggio.



Eurobrico S.p.A. non risponderà di danni, perdite, anomalie e malfunzionamenti che siano causati da installazione, uso, manutenzione errati o comunque difformi rispetto alle prescrizioni contenute nel presente manuale.

OBBLIGO DI UTILIZZO DI GUANTI ANTITAGLIO E DISPOSITIVI DI PROTEZIONE INDIVIDUALE DURANTE IL MONTAGGIO.

Alcune parti del prodotto possono risultare taglienti; pertanto, le stesse sono da maneggiare con cura e solo ed esclusivamente indossando specifiche protezioni. Eurobrico declina ogni responsabilità in caso di lesioni causate dal non rispetto del presente manuale.

Eurobrico Spa declina ogni responsabilità nel caso in cui l'acquirente non segua pedissequamente le istruzioni di montaggio ed i consigli e avvertenze previsti, munendosi dell'adeguata attrezzatura necessaria, il tutto come indicato nel presente manuale Domus "Istruzioni di Montaggio".

Prodotto importato da:
EUROBRICO SPA
VIA DELLA STAZIONE 100
38059 CASTEL IVANO (TN)
www.eurobrico.com
PUC: <https://rebrand.ly/SicurezzaEB>

Made in China